

# **MiniSub<sup>TM</sup>**

*A New Dimension in Distribution Technology*

## **Complete Substation Package**



**POWERSystems**  
TECHNOLOGY LTD

**Small Size • Large Savings • Increased Safety**

# Design Comparison

## MiniSub Designs *"Bring the power to the load"*

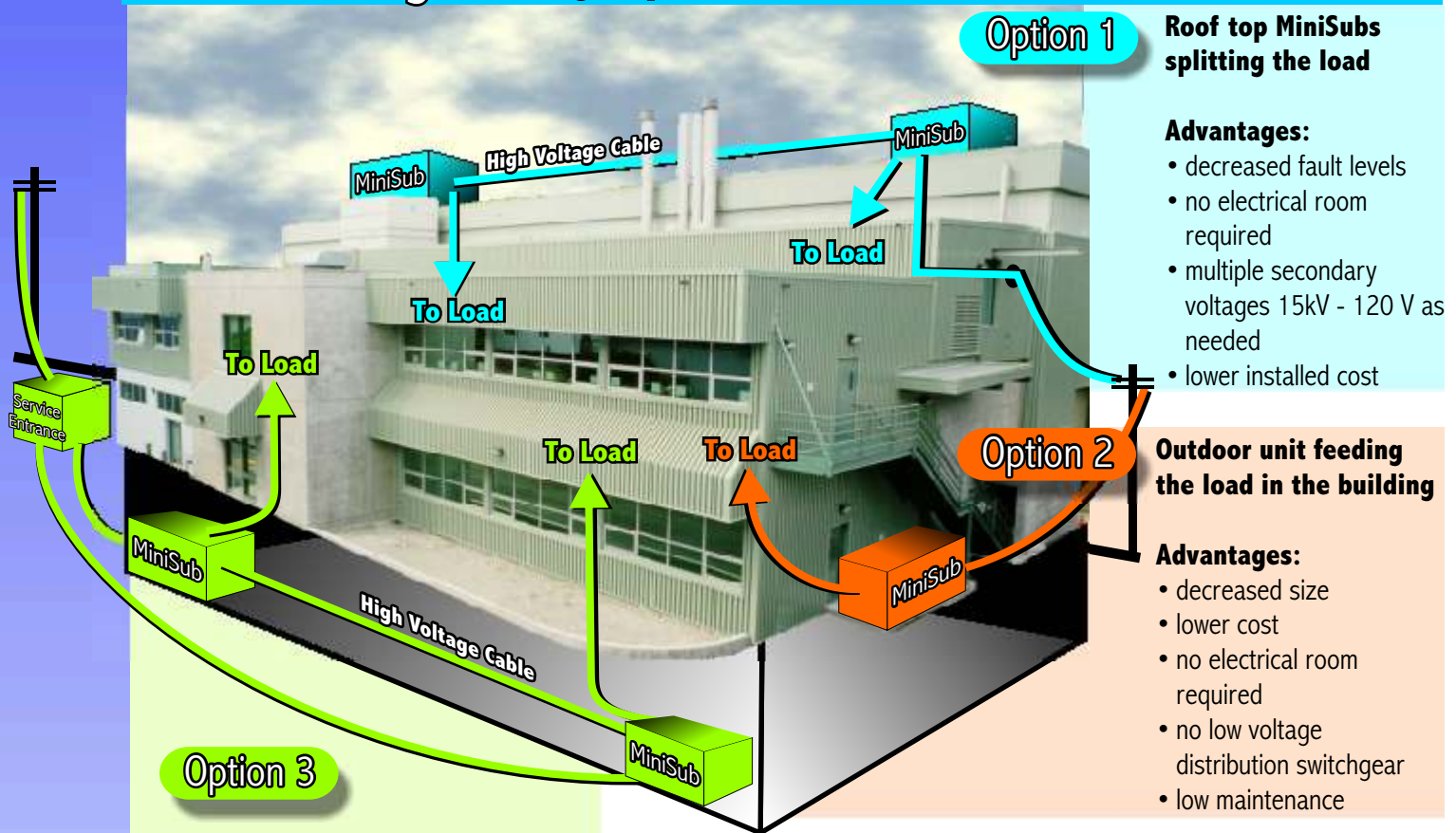

### Option 1

#### Roof top MiniSubs splitting the load

##### Advantages:

- decreased fault levels
- no electrical room required
- multiple secondary voltages 15kV - 120 V as needed
- lower installed cost

### Option 2

#### Outdoor unit feeding the load in the building

##### Advantages:

- decreased size
- lower cost
- no electrical room required
- no low voltage distribution switchgear
- low maintenance

### Option 3

#### Loop feed system created with a loop switch

##### Advantages:

- lower cost in cables at high voltage
- no electrical room needed
- isolate each connection while maintaining power to the rest of the loads
- low maintenance
- lower fault levels

## Traditional Designs

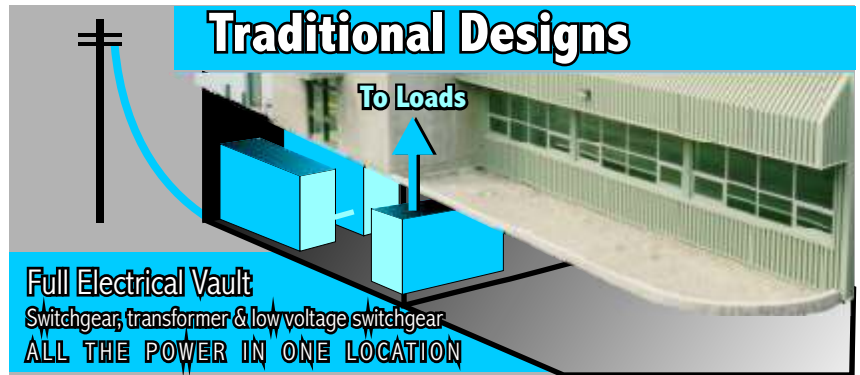

## Key Features

- Compact size, only slightly larger than a padmount transformer. This unit can house up to 3 load break primary disconnects, fusing, transformer, secondary metering and distribution
- Primary load break switches offer gas filled technology to provide maintenance-free service for the unit's life
- All parts are quickly replaceable
- All the primary compartments are submersible. There are no live parts, including the cable connections!
- Available in an automatic transfer from 2 primary feeds
- Secondary can accommodate a wide selection of breaker styles
- Very low EMF Emissions mean the MiniSub can be installed anywhere
- Dual voltage secondary

## RADIAL

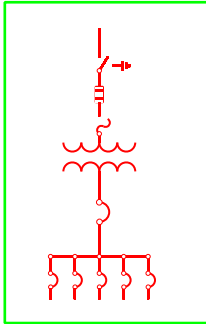

RADIAL MINIBUS

(H) 2010mm x (W) 2164mm x (D) 2478mm  
WEIGHT : 6245kg. Based on 1500 KVA.

### Applications

- condominiums
- schools
- apartments
- commercial

### Advantages

- can eliminate large expensive low voltage switchgear
- less space used
- time to design
- lower cost
- can include utility metering compartment

## LOOP FEED

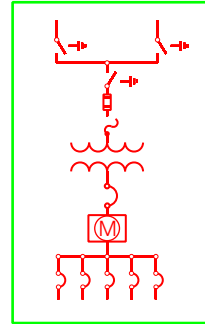

LOOP MINIBUS PLUS PUC

(H) 2010mm x (W) 2164mm x (D) 2478mm  
WEIGHT : 6445kg. Based on 1500 KVA.

### Applications

- universities & colleges
- industries
- large companies
- apartments (splitting up the load)
- commercial

### Advantages

- isolate one connection without a major disruption
- split a large load to decrease KVA and KAIC

## DOUBLE ENDED

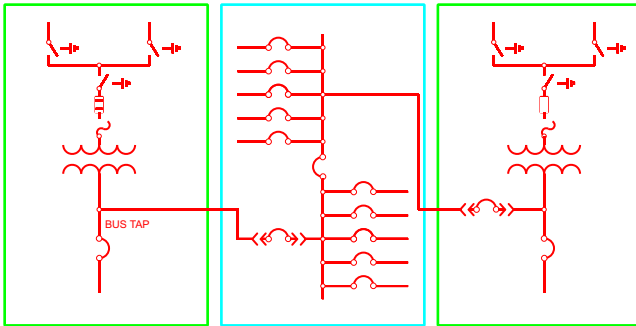

LOOP MINIBUS PLUS

LV SWITCH BOARD

LOOP MINIBUS PLUS TAP

(H) 2010mm x (W) 1727mm x (D) 2478mm  
WEIGHT : 6105kg. Based on 1500 KVA.

### Applications

- government
- high tech industry
- critical loads

### Advantages

- always have at least one source feeding the load
- no downtime
- ease of design

## INJECTION SUB

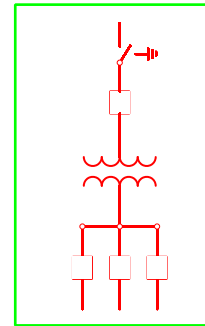

INJECTION MINIBUS

(H) 2061mm x (W) 2950mm x (D) 3270mm  
WEIGHT : 9735kg. Based on 3 MVA.

### Applications

- utilities
- universities & colleges
- industry

### Advantages

- medium voltage to MV tamperproof box
- small size
- convenient
- less cost

## DUAL SOURCE

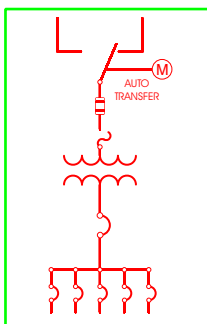

DUAL SOURCES  
AUTOTRANSFER MINIBUS

(H) 2010mm x (W) 2164mm x (D) 2478mm  
WEIGHT : 6245kg

### Applications

- pumping stations
- anywhere that requires critical power
- hospitals
- airports

### Advantages

- generator backup
- auto transfer available
- UPS backup

## NETWORK SUB

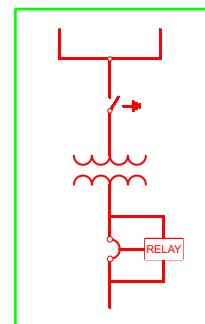

NETWORK MINIBUS

(H) 2010mm x (W) 1727mm x (D) 2478mm  
WEIGHT : 5905kg. Based on 500 KVA.

### Applications

- utilities

### Advantages

- connect to a grid of power optimizing your loads uptime



## A Unit Substation Certified for Any Installation



The Power Systems MiniSub is a new concept in unit substation design which brings together the unique benefits of oil / liquid filled padmount transformers as defined by the CSA specification C227.4 and SF6 switching technology using the Arc-Whipper™ three position switch.

This combination of technologies and the use of the ANSI -386 connection method gives the MiniSub package the ability to be installed in all kinds of environments, for utility or customer operation. The MiniSub requires minimum maintenance, and offers a higher degree of safety than conventional equipment.

Our MiniSub is available in a wide variety of voltages and sizes; from 5kV through to 34.5kV and from 150

to 10,000KVA. Switching can be a simple on/ off switch, up to a multiple switch and breaker arrangements for primary loop systems. Two sources with automatic transfer are available with a number of options.

This new more compact design is able to be installed indoors or outdoors in fire rated or non-fire rated environments, allowing the designer to look at the application of power to



*Double Ended MiniSubs*

a building in a new way. No longer do we need to supply large KVA in only one location with the need for heavy power switch boards at high interrupting levels, and large cables to feed the loads.

With the use of the MiniSub's loop features, secondary protection and utility metering package, power can be injected into the building at several locations, feeding standard distribution panels, bringing the transformation closer to the load as is done with secondary low voltage transformers. The overall savings of switchgear and cabling will be most attractive to owners and maintenance people.

Power Systems looks forward to enquiries for all your designs.

## Construction Features

ARCWHIPPER SF6\* loadbreak switches are ruggedly constructed, incorporate proven design and are rated/tested in accordance with ANSI standards C37.71-1984, C37.72-1987 and CSA T.I.L. D25 for long life with little maintenance.

Switch contacts are equipped with very high speed auxiliary arcing contacts to quickly interrupt in ¼ to ½ cycle, leaving main contact surfaces undamaged by arcing. The arcing contact allows main contacts to be designed for high continuous, fault close and momentary current performance.

Switches are factory filled with non-toxic, non-flammable, high dielectric SF6 gas insulation.\* SF6 quality and stability are maintained by use of totally sealed tank construction, an internal purifying absorbent and the extremely fast ARCWHIPPER interrupter. A color coded, field replaceable pressure gauge and self-sealing fill valve allow monitoring and addition of SF6 as necessary.

Switch tanks are ¼" thick steel with a highly corrosion/abrasion resistant 5 mil epoxy finish. External fittings and fasteners are marine grade stainless steel or bronze. For increased corrosion resistance, stainless steel tanks can be provided.

Current carrying parts are high conductivity electrolytic grade copper with plating, locking fasteners, and torque wrench assembly to assure permanent low resistance connections.

Moving contacts are self-aligning, self cleaning (*wiping type*) and designed to increase contact pressure with increasing currents. Contact assemblies are supported by high strength, molded glass polyester

insulation with flex connectors at critical locations to prevent stressing and misaligning due to high current or mechanical forces.

## Ratings

ARCWHIPPER SF6 loadbreak switches are designed, tested and rated per applicable sections of IEEE, ANSI, NEMA, CSA T.I.L. D25 and other industry standards including:

- CSA T.I.L. D25 standard for Pressurized Gas Insulated Switchgear.
- ANSI C37.71-1984 Standard for Subsurface Load Interrupting Switches.
- ANSI C37.72-1987 Standard for Padmounted Load Interrupting Switches.
- ANSI/IEEE 386 Standard for Separable Connectors and Bushings.
- IEC 265 International Standards for Load Interrupting Switches.
- ASTM D-2472 Specification for Commercial Type Electrical Grade SF6.
- ANSI C57.12.28 Standard for Padmount Enclosures.



*ArcWhipper Contact*



*Gas Pressure Gauge*



*MiniSub with loop switch, vacuum breaker at 27.6 kV, 150 kV BIL, secondary metering, main breaker and TVSS*



*Three position load break switch  
Closed - Open - Closed*



# Primary Switching



Load Break Switches



3 Phase loop switch configuration with transformer switch



V-MAG Vacuum Circuit Breaker 600 amp

## Application Information

ARCWHIPPER SF6 loadbreak switches are completely submersible, fully deadfront, and corrosion resistant for application in the harshest conditions including areas subject to flooding, severe contamination, rodents and snakes, blowing snow/dust, sea coasts, high altitude, and even Division 2 hazardous locations. Non-toxic, non-flammable SF6 insulation permits installation indoors or outdoors in high traffic areas. Compact size and reduced weight provide solutions where overall space is important such as in high-rise buildings, front lot lines and in small vaults.

## Switch Operators and Options

ARCWHIPPER SF6 load break switches are equipped with external handles for manual operation as standard. The handle can be padlocked in all switch positions and has an anti-reversing feature for additional safety. Interlocks can be provided as may be required by local practice and for increased safety.

In addition, remote/SCADA and fully automatic operators are available for increased levels of control and system automation. These motor operators attach to the switch handle and may be easily disconnected for manual operation.

*\* ARCWHIPPER switches are available with oil, as a replacement for the SF6.*

## Manual Operation

The handles are removable and can be attached to the switch operating shaft through an arc of 360 degrees in 45 degree increments for maximum mechanical advantage during operation or may be removed and stored on the padlockable hanger bracket when not in use. Rotating the handle toward the desired position causes quick make/break, spring operated contact movement independent of the operating handle movement. Latches prevent contact blow off and provide positive position indication. Additional features include: padlock provisions in all positions, bushing oriented line diagram and instructions. Three position switches are equipped with anti-pass through provisions to prevent inadvertent operation to the 3<sup>rd</sup> position.

*Note: All switches are available with a ground position.*

## V-MAG Vacuum Circuit Breaker 600 amp

Breaker comes with electronic relay. The V-MAG is tested in excess of ANSI C37.60 and is a compact MAINTENANCE FREE Vacuum Circuit Breaker with every detail designed for maximum reliability.

A cast resin molding supports the vacuum interrupters and drive mechanism. The vacuum interrupters are driven through a single cast resin beam by the Magnetic Actuator.

Breakers supplied in the MiniSub will have isolating switch ahead to provide visible isolation.

A vacuum breaker is generally used where a standard fuse arrangement is not available.

## Key Interlocks

Are available as required to prevent paralleling feeders or to limit access to energized equipment or to otherwise coordinate proper system operation. Keylocks are mounted on the specified switched ways with locking provided for the required position.

## Manual, Remote or Automatic Switching

ARCWHIPPER is equipped for manual operation as standard and includes: external handles for operation by hand; quick make/break spring operators; bushing oriented line diagram; positive position indicators; padlock provisions; and operating instructions.

Remote operation can also be provided by motor operators with pushbutton or SCADA control. Automatic transfer switches use fast acting motor operators with voltage/current sensing and full function control. Units are factory wired/adjusted.

A electric operator is available with battery pack and charger.

## Automatic Load Transfer Switches

The MiniSub is ideal for maintaining power to critical loads such as hospitals, airports, shopping centers, and industrial facilities. Upon loss of preferred primary feeder voltage, the load is automatically transferred to an alternate source. Optional automatic retransfer, overcurrent detection and fault isolation provide additional system flexibility.

Units include fast acting 24 VDC motor operators attached to the

switch operating handles. Voltage sensing is done through a set of elbow mounted detectors and relay combination which supply data to the full function automatic control with self-contained 120 VAC/24VDC control power source. All items are factory assembled, wired, adjusted, and tested for simplified installation and operation.

## Anti-reverse Operating Handles

Eliminate the possibility of interrupting currents beyond the capability of the switch by preventing immediate operation after closing on a fault. A latch on the operating handle must be reset prior to subsequent operation allowing upstream circuit protection time to clear the fault.



*Visible grounding window*

## Visible Break, Make and Ground

Each switched way is equipped with a viewing window for clear, visual confirmation and assurance of contact position of ALL PHASES. Conforms to local code and operation practices which require visible break and (where equipped) visible grounding during system operation, maintenance, repair, or testing.



*Automatic Load Transfer Switch*



*MiniSub with Primary Auto Transfer Switch*



*Anti-reverse handle with key locks and switch position contacts*



# Transformer



*Cores & Coils*



*Liquid temperature gauge*



*Oil level gauge*

## Transformer Design

Power Systems has chosen to use the basic padmount transformer design which is a proven technology since the 1970's. This transformer design offers an economic and reliable package, making the overall appearance very acceptable.

All transformers used with the MiniSub are built to the CSA C227.4 M1978 or ANSI C57 specification and can conform to CSA C802 or ANSI TP1 specification for efficiency and losses. Custom loss arrangements are available. Transformer sizes are available from 150 KVA up to 10 MVA (depending on voltage class) in 5 to 34.5 kV range. Secondary voltages are available up to 25 kV or ANSI TP1. This gives a very broad range of applications for the MiniSub.

Our transformer designs can also be built to meet the ANSI/IEEE C57.92-1981 guide for loading of oil filled transformers 55°C or 65°C rise, which allows for up to 200% loading where permitted by code.

Transformers are available in standard transformer oil (*ONAN*), or FR3 oil (*LNAN*) for installation in non fire rated environments.

The US/Canadian Electrical Code, State/Provincial Inspection Authorities, and Factory Mutual approve MiniSubs with the LNAN rating, for installation in any location within a building including roof areas without fire barriers, or walls of any kind. Contact us for complete documentation on this and other environmentally friendly cooling liquids for the MiniSub.

## Standard Accessories

- Liquid temperature gauge
- Pressure relief device
- Oil level gauge
- Fill and drain valve
- Transformer riveted cover
- Tap switch and off load 5 position changer
- Copper ground bar in both HV and LV compartments
- Spare fuse holder and fuses
- Lifting and jacking devices
- Tamperproof design with secure hinges and lockable handle.

## Cores

All our cores are cut on in-house TRANCO core cutting machines. The grain oriented steel laminations are then squeezed into rectangular shapes, providing an economical, low loss construction. Stresses developed during cutting and forming are relieved by annealing in an inert gas atmosphere oven. Lamination joints are staggered and precision cut for high performance.

## Coils

Coils are wound on heavy Kraft board forms to provide both high mechanical strength and basic insulation to ground. Heavy end fillers are used to square up the length of the coil and provide clamping surfaces for short circuit strength.

Coils, after winding, are processed in temperature controlled ovens, where moisture is removed from insulation, and thermal bonding of the H.V. conductor and L.V. strip take place. A unique core/coil/frame mounting system assures a stress free assembly resulting in consistently low core losses and low sound levels.

Leads, taps, accessories and internal components are fitted onto the core and coil assembly. The complete ensemble is inspected and tested prior to tanking.



## Fuse Protection

All Power Systems MiniSubs are equipped with a system of Bay-O-Net and back up isolation link. In this arrangement, secondary faults and overload currents are cleared by the Bay-O-Net fuse. If higher fault levels are present, the isolation link can be replaced by an optional current limiting fuse. The two fuses are connected in series. Internal faults are then cleared by the current limiting fuse located inside the tank.

Access to the Bay-O-Net fuse is restricted by a metal cover over the fuse holders which is key interlocked with the ArcWhipper switch, to guarantee that power is in the off position prior to accessing the fuses.

*Note: The application of internal fusing in voltages at 25kV and above can only be done in a wye primary connected design. The load on the transformer cannot exceed more than 50% delta connected secondary loads. A certain condition of ferrule resonance can exist at these voltages and the application of lightning arrestors should be considered.*

*Note: At lower primary voltages some KVA sizes may not be available.*

## MCLF Fuses

For situations as described above the use of MCLF fusing can allow the use of loads greater than 50% Delta when the primary voltage is above 24kV. This can also be solved by using secondary protection to clear any faults.

## Enclosure

All our tanks conform with our stringent quality assurance ISO 9002-94 requirements for welding and painting. Removable front sill allows cables to be pulled and the MiniSub to be moved into place or removed without lifting over cables.

All doors are provided with gaskets, wind lasts, pentahead with shroud and padlocking provision.

## Paint Procedure

The tanks are either powder coated or painted with two epoxy primer coats and two urethane finish coats. An intricate metal surface treatment process insures conformity with the 1500 hr. salt spray test requirements. An anti-graffiti coating is available allowing pressure washing of most paint and markings.

## Envirotemp FR3 Fluid

FR3 Fluid is a Fire Resistant Natural Ester dielectric coolant used where its unique electrical, thermal, safety and environmental properties are needed to meet the code for non-fire rated room.

FR3 Fluid is formulated from edible vegetable oils and food grade performance enhancing additives, non-toxic and ready biodegradable and also compatible with standard insulating materials, components and with fluid processing equipment and procedures.

FR3 Fluid has an exceptionally high fire point of 360C and flash point of 330C. It has the highest ignition resistance of less-flammable fluids currently available. Minisub filled with FR3 Fluid are designed, manufactured, and operated in much the same manner as conventional mineral oil-filled units. FR3 Fluid filled Minisub can be installed in underground parking, roof tops or anywhere a dry type unit can be installed.

Units filled with FR3 can see significant reduction in gassing and have an extended life expectancy.



*Bay-O-Net fusing and interlock*



*Bay-O-Net and backup current limiting fusing*



*MCLF Fuses*



*Spare Bay-O-Net Fusing*



*LV Grounding Connection*



*Typical Loop Connection*



*Fuse Interlock Protection*



*Voltage Sensor*

## Primary Cable Terminations

ANSI/IEEE standard 386 defines the specific interface dimensions that 200 and 600 amp, elbows, inserts and equipment bushings must conform to in order to insure interchangeability. The 200 amp load break, and 600 amp non load break connectors provide a convenient and safe way to connect all primary cables.

While the cables and terminations are barriered from access, the elbow test point offers an additional security and safety, as well as a voltage reference for automatic or SCADA type operations. This termination provides a dead front waterproof connection.

*Note: Inserts and elbows are not supplied as part of the MiniSub unless specified.*



*200 amp terminator with voltage test point*

## Insulated Flexible Dry Jumper

The jumper, composed of braided copper conductor with silver plated terminals compressed on both ends and insulated with acrylic coated fiberglass sleeve secured with heat shrink, this gives maximum flexibility eliminating contraction and stress problems as in rigid buses



*Insulated Flexible Dry Jumper*

## The Ground Connection

MiniSubs are provided with a ¼ by 1½ in. copper ground bus throughout the substation. SF6 switch tanks and shielding components are grounded to the main ground bus.

The secondary neutral point is grounded in different ways depending on the secondary equipment supplied.

## Switch/Transformer Interconnection

This unique 600amp connection between the SF6 switch and the transformer allows the switch to be plugged in for a water tight connection. This feature allows the switch to be removed in the field for service, if required. A switch can be replaced with this method in a few hours.



*Air/Water Tight Switch Connection*

## Elbow Sensors

### *Elbow Test Point Voltage Sensors:*

Elbow test point mounted voltage sensors offer indication of low or no voltage status. Provides a normally open contact for healthy condition (*standard equipment on auto transfer unit*).

### *Elbow Current Sensor:*

Current sensors can be mounted on the elbow connections or switch unit with different primary & secondary ratings.



# Secondary Distribution & Options

## Secondary Distribution

The MiniSub can be ordered with a large selection of secondary distribution to eliminate the need for switchboards or switchgear. The front low voltage side can house up to three 1200 amp molded or insulated case breakers. Alternatively, a single breaker up to 3000 amps can also be mounted in this section.

When further distribution is required, the MiniSub can be ordered with a right side mounted distribution panel rated up to 1200 amps with a main breaker located in this section or up to 2000 amps with the main breaker located in the front section. A public utility compartment can be placed in the top/bottom part of this section but will limit the interior space. (see charts A, B and C on pg. 15 for available breaker fill sizes.).

When ordering a split distribution section with no main breaker the total of the branch breakers should not exceed the primary fuse rating by 150%. In splitting the secondary bus at the bushings of the transformer, significant cost savings can be had by the smaller cabling required.

## Utility Network MiniSubs

By adding a standard breaker with our network relay for the functions of line and load voltage check, reverse power, line and load phase rotation, and overload protection, the MiniSub can be used as a non-submersible tamperproof network transformer and protection unit for installations in Utility Network Systems. The network MiniSub can offer complete SCADA functions on both primary, secondary and transformer functions. The full load break and fault closing capabilities of our closed, open, and ground primary switch offers greater safety and security for the operators.

## Auto Transfer Package L.V. Side

If two secondary breakers are installed they can be converted to an automatic transfer switch (*note this can not be used for life safety requirements*) the breakers are interlocked mechanically and electrically, and provide with a control package to handle the transfer and call for the generator to start.

## Auto Transfer Package H.V. Side

See page 5 for details.



Low Voltage Breakers



Side Distribution Panel with Utility Metering Compartment

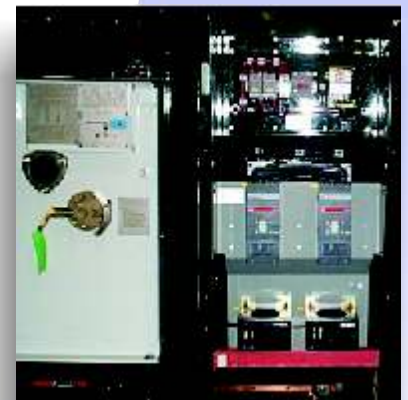

Dual breakers with monitoring



# Options & Accessories

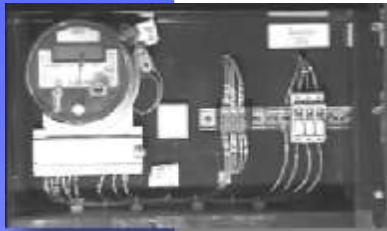

Utility Metering Provision



Customer Metering



Transient Voltage Surge Suppressor



Customer Multipoint Metering

## Meter Reader's Door

Tamper proof door 6" square with a locking hasp can be provided to allow access to meter readers only. Access to all of the live parts is barred off.

## Utility Metering Primary

A separate compartment is provided on the left side of the transformer tank with three 200 A bushings in and out for connection to a Sadtem KYE24 metering tank. Access door is key interlocked with main switch for dead access only. These bushings are taken after the fuse protection. (*connections and metering tank by others unless requested*) Secondary connections are brought out to the LV compartment with shorting blocks, fuses, and provision for utility meter. If a stand-alone metering enclosure is required the compartment has only enough space for entrance and exit cables.

## Utility Metering Secondary

(*Without the side panel*) Low voltage CT's and PT's are mounted behind the secondary metering panel and provision for meter as shown. (*With a side panel section*) The bottom or top half of the panel is provided with a standard utility compartment for installation of CT's and PT's by the Utility. The meter can be installed in the front metering compartment or outside the unit as required

## Customer's Metering

As described in the utility metering, except supplied with one of the digital packages available from several suppliers.

## Customer Multi-Point Metering

For customer owned metering systems, The Intellimeter system can meter electricity, gas, water, BTU's for up to 80 points and is accessible via modem connection to a central billing system.

## SF6 Refill Kit

This kit is ideal for normal maintenance or emergency refills needed to 'Top Off' or to bring the pressure up to operating levels. All Power Systems load break switches use sulfur hexafluoride (SF6) gas as the insulating and interrupting medium.

## Pentahead Socket



Special five sided shrouded bolts are provided on all doors for tamperproofing. A special five sided socket can be purchased.

## TVSS

The transient voltage surge suppressor (TVSS) is designed to protect sensitive electrical and electronic equipment against the harmful effects of lightning strikes, externally and internally generated transients as well as high frequency noise.

Our TVSS uses proven Metal Oxide Varistor (MOV) technology and an efficient capacitive filter system to reduce or eliminate surge problems within an electrical system.

Notes:

TVSS surge current ratings are available from 60kA through 150kA/per mode and include one 100A molded breaker for protecting TVSS from damage.

## Lightning Arrestors Elbow Type

Power Systems offers the option of lightning arrestors by the use of metal oxide surge arrestors mounted on the transformer wall below the Bay-O-Net fuses. See chart to chose arrestor MCOV rating. *Note: Only provision is provided, if not specified.*

## Cable Retrofit Kit

Converts transformer connection to standard elbow connection. Specify type of elbow 200 or 600 A.

## Smart Sub

Monitors contacts within the MiniSub Internal Modem will call a predetermined telephone number and advise of revised status. Unit comes with battery backup and touchpad (*must be ordered with S.M. package*).

## ARC Guard

The purpose of the Arc Guard System is to quickly detect the arc fault and disconnect an upstream breaker. Please visit our web site for more information.

## Static Capacitor Bank

Located in the LV section below the bushings, this is a MPP type low loss polypropylene foil interlayered with metalized kraft paper. These units are self healing, and can handle ambient temperatures up to 70°C. Capacitors can be sized up to 120 KVAR and are supplied with a disconnecting breaker.

## Oil Dam Kit

A metal barrier provided around the transformer and cable openings to hold oil leaked from the transformer. For use where standard concrete dam or reservoir tanks are not available

## Special Key Interlocks

All switches and secondary breakers can be provided with key interlocks as required.

## Anti Graffiti Paint

A special final coating which seals the paint finish allowing spray paint to be pressure washed off.

## S.M. Package

Supplies remote monitoring contacts for gas pressure, switch position, as well as oil level and temperature. This combined with the automatic motor operator allows for a complete SCADA package.



Lightning Arrestors



Switch Position Contacts



Static Capacitor Bank



Oil Dam Kit

# Testing & EMF Emissions



*Testing Console*



*Final Testing Bay*



*Switch Testing Bay*

## **Transformer**

All tests are carried out in accordance with requirements described customer's specification and NEMA, CSA and ANSI standards.

1. Resistance measurement of all windings on the rated voltage connection and at the tap extremes
2. Ratio tests on the rated voltage connection and on all tap connections
3. Polarity and phase relationship
4. Core insulation
5. Exciting current and no-load losses at rated voltage
6. Impedance and load losses at rated current on the rated voltage connection & corrected to 85° C;
7. Applied potential
8. Induced potential
9. Pressure test to establish the integrity of the tank

## **Switch**

Switches are designed and tested to meet requirements and/or applicable NEMA and ANSI (S37.71 C37.72) CSA standards.

1. Low frequency, high potential test verifies the electrical integrity of the insulation system.
2. Circuit resistance test verifies that

all contacts are properly aligned and current transfer points properly assembled.

3. Leak Test verifies that a leak does not exist which could impair the dielectric integrity of the unit during its anticipated service life.
4. Operating assurance test verifies the mechanical performance of the switch; that all contacts and indicators are correct for all switch positions, that liquid level indicators function properly, and that nameplate and circuit diagrams are correct.
5. Partial Discharge (*CORONA*) test is used only when the insulation system contains material which may be subject to deterioration due to a corona or partial discharge.

## **Secondary Breakers**

1. High Potential (*HiPot*) Test
2. Torque Test
3. Function Test

## **MiniSub Assembly**

1. HiPot
2. Operational test of all devices associated with the transformer;
3. Insulation on auxiliary devices and wiring;



## **Low EMF Emissions**

*All standard MiniSubs offer the unique properties of very low emissions of electromagnetic fields. This allows the installation of MiniSubs in areas previously restricted to this kind of equipment without shielding.*

*Consult factory for test results.*



## SF6 Switch Ratings

### Voltage Ratings

Maximum Design Voltage	5/15.5 kV	25/27.6 kV	38 kV
Frequency	50/60 Hz	50/60 Hz	50/60 Hz
BIL impulse withstand	95/110 kV	125kV	150 kV
One minute AC withstand	35 kV	60 kV	70 kV
Fifteen minute DC withstand	53 kV	78 kV	103 kV
Corona extinction	11 kV	19 kV	26 kV
Open Gap BIL Flashover withstand	200 kV	200 kV	200 kV

### Current Ratings

Load interrupting and loop switching	600 A	600 A	600 A
Transformer magnetizing interrupting	25 A	25 A	25 A
Capacitor or cable charging interrupting	40 A	40 A	40 A
Asymmetrical momentary and 3 operation fault close	40 kA	40 kA	40 kA
Symmetrical two second rating	25 kA	25 kA	25 kA
Continuous current	600 A	600 A	600 A
Symmetrical 10 cycle phase to phase simulated internal fault withstand	25 kA	25 kA	25 kA

### Mechanical Ratings

Ambient temperature range	- 40 ( <i>oil</i> -56) to + 120 degrees C.
Mechanical life	2000 operations
V-MAG	10,000 operations
Corrosion resistance per ASTM B-117	2000 hours
Maximum leak rate	10 <sup>-7</sup> cc/second
Normal gas pressure @ 68 degrees F.	6 psi
Maximum design gas pressure	15 psi

## Vacuum Breaker Ratings

Rated voltage	15 kV	27.6 kV	38kV
Rated normal current	600 A	600 A	600 A, 1250 A, & 2000 A
Impulse withstand voltage	95 kVp	125 kVp	170 kVp (200 kVp)
Rated frequency	50/60 Hz	50/60 Hz	50/60 Hz
Duration of short time current	3 secs	3 secs	3 secs
Rated short-circuit making current, peak			
Rated short-circuit breaking current, rms	12.5/16 kA	12.5 kA	10/25/31.5 kA
Rated operating sequence (IEC)	0 – 0.3 sec. – C – 3 min. - CO		
Rated operating sequence (ANSI)	0 – 0.3 sec. – C – 15 sec. - CO		
Rated control supply voltage	110/125 VDC (220 & 48 VDC Optional)		
Control supply current (continuous)	70 mA max. (110/125 VDC)		
Rated circuit breaker supply voltage	110/125 VDC (220 & 48 VDC Optional)		
Ambient operating temperature range	-50 C to + 50 C		
Service life	30 years or 10,000 Circuit Breaker Operations		

# Weights and Dimensions

KVA	A	B	C	D	E	F	TOTAL WEIGHT	OIL OR FR3
150	70.5	27.4	--	43.1	78.4	14.25	6801lb/ 3091kg	1280L
225	71.5	28.4	--	43.1	78.4	14.25	8671lb/ 3941kg	1695L
300	71.5	28.4	--	43.1	78.4	14.25	8671lb/ 3941kg	1695L
500	73.3	30.2	--	43.1	78.4	14.25	9966lb/ 4530kg	1570L
750	85.4	28.4	13.9	43.1	78.4	14.25	10065lb/ 4575kg	1865L
1000	93.3	28.4	21.8	43.1	78.4	14.25	11682lb/ 5310kg	1870L
1250	93.3	28.4	21.8	43.1	78.4	14.25	11682lb/ 5310kg	1870L
1500	96.4	31.4	21.9	43.1	78.4	14.25	12694lb/ 5770kg	2020L
2000	94.1	30.9	20.1	43.1	78.4 <td 14.25	13222lb/ 6010kg	1865L	
2500	99.4	34.4	21.9	43.1	78.4	14.25	17732lb/ 8060kg	1750L
3000	104	38.9	22.0	43.1	78.4	14.25	18200lb/ 8273kg	2200L

NOTES : 1. ALL DIMENSIONS ARE IN INCHES 2. TOTAL WEIGHTS DON'T INCLUDE PANEL AND BREAKERS IN L.V. 3. LV BREAKER PANEL IS OPTIONAL ITEM 4. ALL DIMENSIONS, WEIGHTS AND COOLANT ARE APPROXIMATE, AND MAY CHANGE UPON PRIMARY/SECONDARY VOLTAGES AND CONFIGURATION

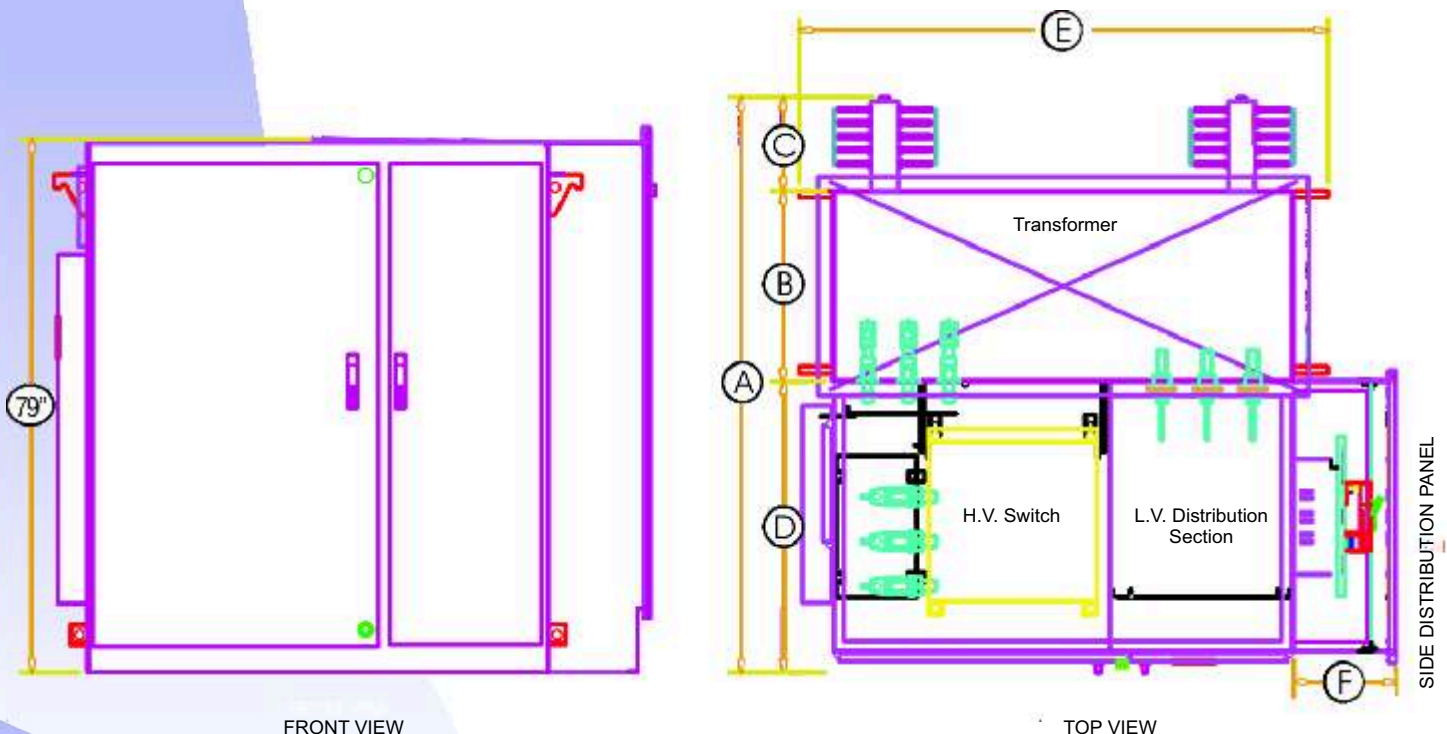

# Calculating Interior Capacities

## Low Voltage Distribution Panel Instructions

- 1 – Choose main breaker and location
- 2 – Choose bus size in amps max 2000
- 3 – Choose interior height ( \_x) chart A
- 4 – Fill interior based on chart B
- 5 – When P.U.C is mounted in CDP, the highest interior height available is 23X (1200A)

\* Main breaker over 1200 Amp is mounted in front LV compartment of MiniSub

\*\* SK-1200A/800A breakers can only be single branch mounted in CDP panel interior

\*\*\* The breaker quantity depends on current rating. For details consult Power Systems Technology

\* The "X" value is 1.375 inches

Main Breaker	Interior Height	Max. Branch Breaker ***
SK-1200A**	28X	14
SK-1200A**	23X	10
SK-800A**	28X	14
SK-800A**	23X	10
SG-600A	28X	16
SG-600A	23X	12
SG-400A	28X	16
SG-400A	23X	12
SG-400A	18X	8
SF-250A	28X	16
SF-250A	23X	12
SF-250A	18X	8

**CHART A**  
Main Breaker\* and Branch Breaker in CDP

Frame	Maximum Amperes	Available Rating Plug Amperes	"X" Value*
SE-FRAME	30	15 20 25 30	3
	60	40 50 60	3
	100	70 80 90 100	3
	150	110 125 150	3
SF-FRAME	250	70 90 100 110 125 150 175 200 225 250	3
SG-FRAME	400	125 150 175 200 225 250 300 350 400	4
	600	250 300 350 400 500 600	4
SK-FRAME	800	300 400 500 600 700 800	6
	1200	600 700 800 1000 1200	6

**CHART B**  
GE Spectra RMS Circuit Breaker Size and Current Rating

FRAME	TYPE	BREAKER SIZES	AVAILABLE PLUG RATINGS AMPERES	3 PH 208Y/120	BREAKER KAIC	
					3 PH 480Y/277	3 PH 347Y/600
SE	SEDA	150	15-150	18	14	14
	SEHA	150	15-150	65	25	18
	SELA	150	15-150	100	65	25
	SEPA	150	15-150	200	100	25
SF	SFHA	250	70-250	65	25	18
	SFLA	250	70-250	10	65	25
	SFPA	250	70-250	200	100	25
SG	SGDA	400	125-600	65		
	SGFA	400/600	125-600	65	35	25
	SGLA	400/600	125-600	100	65	65
	SGPA	400/600	125-600	200	100	65
SK	SKHA	800/1200	300-1200	65	50	25
	SKLA	800/1200/	300-1200	100	65	42
	SKPA	800/1200	300-1200	200	100	65

**CHART C**  
Spectra RMS Circuit Breaker I.c.: Ratings: UL489 and CSA C22.2 RMS Symmetrical Amp(kA) 50/60Hz



# Order Form (Page 1 of 2)

DATE		QUOTE #		OFFICE USE ONLY	
COMPANY		CONTACT			
ADDRESS		PROJECT			
PHONE	FAX	EMAIL			

<b>1</b>	<b>Substation Specifications</b>	VOLTAGE CLASS	KVA	BIL	KAIC	FREQUENCY
----------	----------------------------------	---------------	-----	-----	------	-----------

<b>2</b>	<b>Select Switch Arrangement</b>	<input type="checkbox"/> SINGLE SWITCH	<input type="checkbox"/> DUAL SOURCE	<input type="checkbox"/> GR	<input type="checkbox"/> GR	<input type="checkbox"/> MOTOR	
		<input type="checkbox"/> GROUND	<input type="checkbox"/> AUTO TRANSFER	<input type="checkbox"/> GR	<input type="checkbox"/> GR	<input type="checkbox"/> MOTOR	
		CABLE CONNECTIONS: <input type="checkbox"/> 200 AMP <input type="checkbox"/> 600 AMP				VOLTAGE _____ See Notes on Control	

<b>3</b>	<b>Select Type of Protection</b>	<input type="checkbox"/> STANDARD	<input type="checkbox"/> HIGH FAULT	<input type="checkbox"/> MOLDED CURRENT LIMITING FUSES	<input type="checkbox"/> BREAKER AND RELAY
		ISOLATION LINK BAY O NET MAX 2.3 KAIC	BACK UP CURRENT LIMITING MAX 50 KAIC	FULL RANGE FAULT CURRENT PROTECTION (FOR 25KV AND UP)	RELAY <input type="checkbox"/> 12 KAIC <input type="checkbox"/> 16 KAIC <input type="checkbox"/> 24 KAIC <input type="checkbox"/> 31.5 KAIC
Maximum fuse size available 5 kV - 750 KVA 15 kV - 2500 KVA 25 kV - 3000 KVA 35 kV - 3750 KVA A breaker is required above these listed ratings.					

<b>4</b>	<b>Select Transformer Design Size and Voltages</b>	<input type="checkbox"/> DELTA / WYE	<input type="checkbox"/> WYE / WYE	<input type="checkbox"/> WYE / DELTA
		Primary Voltage _____ Secondary Voltage _____	Primary Voltage _____ Secondary Voltage _____	Primary Voltage _____ Secondary Voltage _____
Primary & secondary dual voltages available. Consult factory.		FLUID: <input type="checkbox"/> OIL <input type="checkbox"/> FR3      TEMPERATURE RISE: <input type="checkbox"/> 65°C <input type="checkbox"/> 55°C		

**If Only Low Voltage Panel is Required - Please Proceed to Step 6** ➔

<b>5</b>	<b>Select Secondary Connections</b>	<input type="checkbox"/> SPADE BUSHING	<input type="checkbox"/> MAIN BREAKER	<input type="checkbox"/> DUAL BREAKERS	<input type="checkbox"/> BREAKERS	<input type="checkbox"/> UTILITY NETWORK BREAKER
		<input type="checkbox"/> BUS DUCT EXIT NO LUGS SUPPLIED	<input type="checkbox"/> BUS DUCT EXIT MAX 3000 AMPS LI, LSIG	AMP _____ MAX 1600 AMPS LI, LSIG	AMP _____ AMP _____ MAX 1200 AMPS LI, LSIG	AMP _____ AMP _____ AMP _____ MAX 1200 AMPS LI, LSIG
Equipment in front compartment						

**If No Low Voltage Panel is Required - Complete Step 5 Then Skip to Step 7** ➔

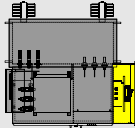
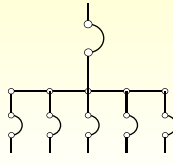
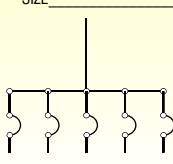
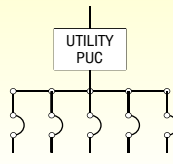
<h2>6 Side Panel Configuration</h2> <p>Main breaker over 1200A must be in Section 5 (due to size constraints)</p> 	<input type="checkbox"/> MAIN BREAKER SIZE _____  MAXIMUM 1200 A	INSERT BREAKER SIZES REQUIRED (SEE PAGE 14) _____ _____ _____ _____ _____ _____ _____ _____	<input type="checkbox"/> IF MAIN BREAKER REQUIRED (see Step 5) SIZE _____  MAXIMUM 2000 A	INSERT BREAKER SIZES REQUIRED (SEE PAGE 14) _____ _____ _____ _____ _____ _____ _____ _____	<input type="checkbox"/> IF MAIN BREAKER REQUIRED (see Step 5)  MAXIMUM 2000 A	INSERT BREAKER SIZES REQUIRED (SEE PAGE 14) _____ _____ _____ _____ _____ _____ _____
---	---	---	---	---	---	--

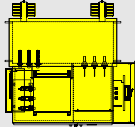
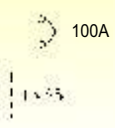
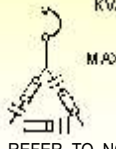
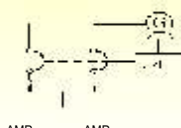
<h2>7 Select Options</h2> <p>See Catalogue for More Information on Individual Options</p> 	<input type="checkbox"/> TVSS  100A SURGE CURRENT _____	<input type="checkbox"/> CAPACITOR  KVAR _____ MAX 1120 KVAR REFER TO NOTES	<input type="checkbox"/> AUTO TRANSFER  AMP _____ AMP _____ REFER TO NOTES
	<input type="checkbox"/> METER READERS DOOR <input type="checkbox"/> OIL DAM KIT <input type="checkbox"/> CUSTOMER METERING TYPE _____ <input type="checkbox"/> SWITCH REMOVAL CRADLE <input type="checkbox"/> CABLE RETROFIT KIT <input type="checkbox"/> ELBOW ARRESTORS <input type="checkbox"/> TERMINATION ELBOWS AND INSERTS <input type="checkbox"/> SUBMERSIBLE LOW VOLTAGE BOX		<input type="checkbox"/> SMART SUB (REQUIRES SM PACKAGE) <input type="checkbox"/> ARC GUARD COMPLETE WITH TWO SENSORS <input type="checkbox"/> SPECIAL KEY INTERLOCKS <input type="checkbox"/> PRIMARY UTILITY METERING PROVISIONS <input type="checkbox"/> SECONDARY UTILITY METERING PROVISION <input type="checkbox"/> AUTO TRANSFER PACKAGE H.V. SIDE <input type="checkbox"/> ANTI GRAFFITI PAINT

<h2>8 Notes</h2>	<b>Standard Accessories</b> Transformer Taps (4 - 2.5 % 2 FCAN & 2 FCBN) Off Load Tap Switch Pad Lockable Oil Drain Valve Complete with Sampler Valve Oil Fill Valve Pressure Relief Valve Oil Level & Temperature Guage SF6 Pressure Guage SF6 Refill Valve Ground Bus Spare Bay-o-net Fuses Lifting Lugs Tamper Proof Design Lifting & Jacking Provision
------------------	---

**Price:** \$ \_\_\_\_\_ *Note: Tax not included in price. Price is valid for 30 days and is subject to our Terms and Conditions below.*

Exceptions: \_\_\_\_\_

REPRESENTATIVE \_\_\_\_\_ CONTACT \_\_\_\_\_ TELEPHONE \_\_\_\_\_

### Terms and Conditions

Payment Terms: \_\_\_\_\_  
 Factory freight: \_\_\_\_\_  
 ALL TAXES EXTRA. Power Systems Technology (PST) Standard Terms and Conditions of Sale shall apply to all sales made by PST stemming from this quotation. Any additional or different terms contained in buyer's purchase orders, invoices, confirmations or other documents generated by buyer are hereby rejected, and shall not be binding on PST unless PST specifically agrees in writing to accept such additional or different terms. Delay in removing equipment after 3 days, when made available at the factory, will incur additional charges. Equipment not shipped 6 months after order entry is subject to escalation clauses. Past due accounts are subject to a service charge of 2.5% per month. **Complete Terms and Conditions available upon request.**

### Warranty

We warrant our products to be free from defects in material and factory workmanship. When the product described herein is installed and used according to our instructions, the original purchaser from us has the following warranty. If any product of ours is found by us to be defective or not to be as ordered, and a written claim is made to us, we will repair or replace the said product or issue credit for the same at our option, to the original purchaser, F.O.B. factory. This warranty terminates on the earliest of twelve months from date of installation or eighteen months from date of shipment from our plant. There is no other representation, warranty or condition in any respect, expressed or implied, statutory or otherwise, in contract, tort, otherwise, other than the above, nor will we be liable in any way for consequential damages, however caused, including damages arising out of our own negligence or that of our servants, agents or representatives. We expressly disclaim any responsibility for expenses incurred in removing the said defective product or installing or using any replacement product or for loss of time or use of the said defective product, transportation costs, or any other indirect, incidental or consequential damage or inconvenience. This warranty does not apply if our product has been damaged due to improper installation, alteration, abuse or misuse, accident, fire, flood or Act of God.

# Integrated Engineering



SF 6 Switch



Gauges



Metering



Fusing Protection



CT's & Bussing



Primary Connections



BARRIERS

Removable Sill



Breakers

Version 4.0 All Rights Reserved

SAFETY - RELIABILITY - SECURITY

**POWER**Systems  
TECHNOLOGY LTD

LOCAL REPRESENTATIVE

[www.powersystems.ca](http://www.powersystems.ca)

Email: [admin@powersystems.ca](mailto:admin@powersystems.ca)

Tel: (613) 228-7228 1-866-300-1527 Fax: (613) 224-6012

300-30 Colonnade Road North, Ottawa, Ontario, Canada K2E 7J6